

SDR Slide Door Rail

COMPONENTS



SYSTEM FOR 1 1/2" and 3 1/2" COMBINATION WOOD/METAL and ALL METAL FRAMED SLIDE DOORS

SYSTEM STRENGTH

Heavy main wall on verticals combined with steel box girts increases overall strength in doors.

ATTRACTIVE APPEARANCE

Prefinished white aluminum verticals and bottom rails accent colored side-wall metal.

SYSTEM FLEXIBILITY

Various applications to choose from for maximum results with minimum inventory.

DESIGN COMPATIBILITY

Extra leg in "J" trim hides cut metal. Extra deep and extra wide nail/screw groove hides almost any fastener.

ENERGY EFFICIENT

Optional vinyl weather strip seals entire vertical to jamb.

Due to Plyco Corporation's ongoing commitment to product improvement, we reserve the right to change, without notice, product specifications, availability, prices and conditions of sale.

PLYCO

System for Combination Wood/Metal & All-metal Framed Slide Doors

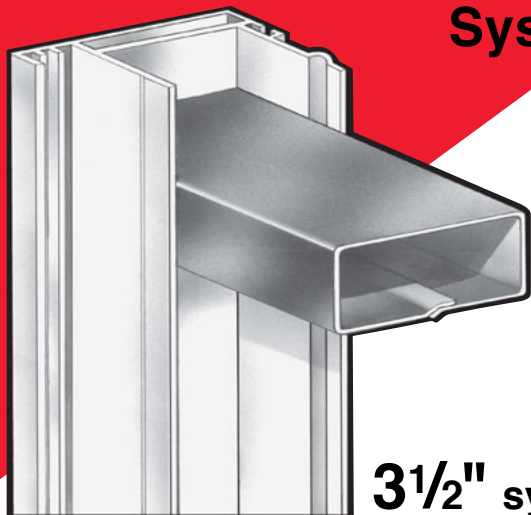

3 1/2" system

- Pre-finished white aluminum verticals
- Steel box girts
- All-metal guide systems



1 1/2" system

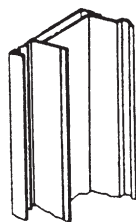

**SDR1635BV
3 1/2" BOX VERTICAL**

- Built-in box extrusion gives best strength to weight ratio.
- Triple "J" Trim accepts vertically all metal heights.
- "J" for flat-cut metal extended and raised to allow easy insertion of sheet and conceals irregular cut.
- Optional weather strip available.
- Back designed not to catch on jamb trim while opening or closing door.
- Available 9, 10, 11, 12, 14, 15, 16, 18 & 20 foot lengths.

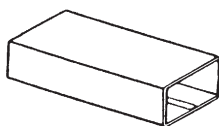

**SDR1635BG
3 1/2" x 1 1/2" BOX GIRT**

- Lock seam tube for best economy, strength, and weight.
- 20 gauge steel G90 galvanized.
- Available in 10, 11, 12, 13'6", 14, 15, 16, 18, 20, 24 foot lengths.

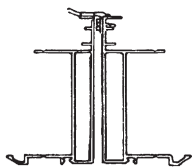

**SDR1635BC
BOX VERTICAL CLOSURE**

- Designed to close the gap between the center of double doors.
- 16' lengths only.

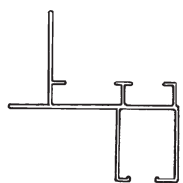

**SDR1635BB
WHITE ALUMINUM
3 1/2" BOX
BOTTOM RAIL**

- (10', 12', 13'6", 14', 15', 16', 18', 20', 24')
- Mates w/SDR1635BV to complete an all-white 3 1/2" application.

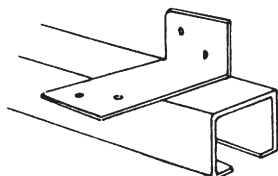

SDR1635BR BOTTOM RAIL

- Dual purpose - attaches to wood or steel girt.
- 18 gauge steel.
- Bottom rail channel mates w/guide rail system.
- Available 8', 10', 12' lengths.

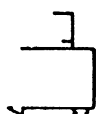

**SDR1600AV
VERTICAL RAIL**

- High nail/screw groove protects jamb.
- Wide nail/screw groove allows nailing without damaging vertical.
- Optional vinyl weather strip wipes against jamb to seal opening.
- Designed to allow easier insertion of girts.
- Available 8, 9, 10, 11, 12, 13, 14, 15, 16, and 18 foot heights.



**SDR1600HC "H"
CLOSURE**

- Simplifies stock.
- Closes gap between and strengthens center of double doors.
- Positive weather seal of door center with optional weather strip.
- Available 10, 12, 14 & 16 foot heights.

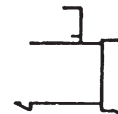

**SDR1600HV "H"
VERTICAL RAIL**

- Economy of including "H" on standard vertical.
- Mates with standard vertical to hold double doors together.
- Positive weather seal of door center with optional weather strip.
- Available 10, 12, 14, 16 and 18 foot heights.



**SDR1600AB
ALUMINUM
BOTTOM RAIL**

- Trims bottom of door.
- Use with door roller.
- 10, 12, 14, 16 & 20 foot lengths - can be spliced.

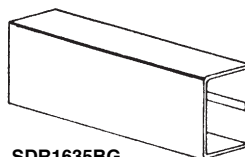

**SDR1635BG
1 1/2" x 3 1/2" BOX GIRT**

- Lock seam tube for best economy, strength and weight.
- 20 gauge steel, G90 galvanized.
- Available in 10, 11, 12, 13'6", 14, 15, 16, 18, 20, 24 foot lengths.

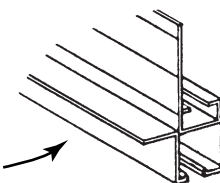

SDR1600WB BOTTOM RAIL

- Continuous nail flange can be cut any length.
- Designed with 1/4" up/down play to compensate for seasonal changes in door and building.
- Dual purpose - Use on wood doors (illus. A). Use on metal doors (illus. B). Nail to wood bottom rail or screw to aluminum vertical rail.
- 10', 12', 14', 16', 18' & 20' lengths help when door opening is full foot wide.

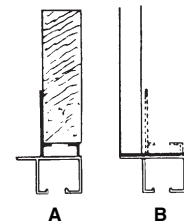

**SDR0500GZ-5' GUIDE RAIL
SDR1000GZ-10'**

- Heavy galvanized steel.
- 5' & 10' lengths - use length or lengths equal to 1/3 - 1/2 the door panel width or more if desired.
- Bracket mounting hole located to allow lead in when door is closed and to aid in installation over metal or other obstruction.
- Holds door down and in.

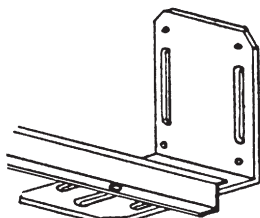

Note: Guide System is designed to give 4 1/4" of in/out and 2 1/4" of up/down adjustment.

GUIDE RAIL SYSTEM

- Designed to provide easy adjustment by building crew or user.
- Provides large amount of adjustment.

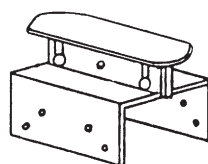

SDR1601CG CENTER GUIDE

- Heavy galvanized steel.
- Attaches on stub post or in cement in center of split doors & large singles.
- Removable stop prevents door from rolling past center.
- Mates w/SDR1635BR bottom rail for 3 1/2" system & SDR 1600WB bottom rail for 1 1/2" system.

OPTIONS

SDR1600 WS WEATHER STRIPPING
Optional vinyl weather strip seals entire vertical to jamb.

See **COMBO** catalog sheet for track, trolley & hardware products.

PLYCO
CORPORATION

Elkhart Lake, Wisconsin 53020
USA 800-558-5895
Fax 800-257-5926
INTERNATIONAL 920-876-3611
Fax 920-876-3527

Distributed by: